



 Unità portatile per l'aspirazione e la filtrazione di fumi di saldatura leggera o a stagno. Dotato di cartuccia filtrante, carboni attivi e cavo di collegamento, MINI90-NEW è la soluzione pronta all'uso per lavori a banco e di precisione.

 Portable unit for filtering and extracting light or tin welding fumes. Equipped with cartridge filter activated carbon cell, connections wire, MINI90-NEW is the right solution ready to be used for bench and precision work.

 Unité portable pour l'aspiration et la filtration des fumées de soudure légère ou à étain. Equipé de cartouche filtrante, charbon actif et câble de connexion, MINI90-NEW est la solution prête pour le travail au banc et de précision.

 Mobile Maschine fuer die Absaugung und Filterung von lichten Schweißrauch oder Hartlötten. Ausgestattet mit Filterkartuschen, Aktivhole und Kabelanschluss, MINI90-NEW ist die fertig Lösung für Werkbank und Präzisionsarbeite.

 Maquinas filtrantes sobre ruedas para la aspiracion y filtracion de humos de soldadura lijera o de estaño. MINI90-NEW lleva cartuchos filtrantes de carbonos activos y cable de connexion electrico y se presenta como una rapida solucion para trabajos de precision y de mesa.



**Light**



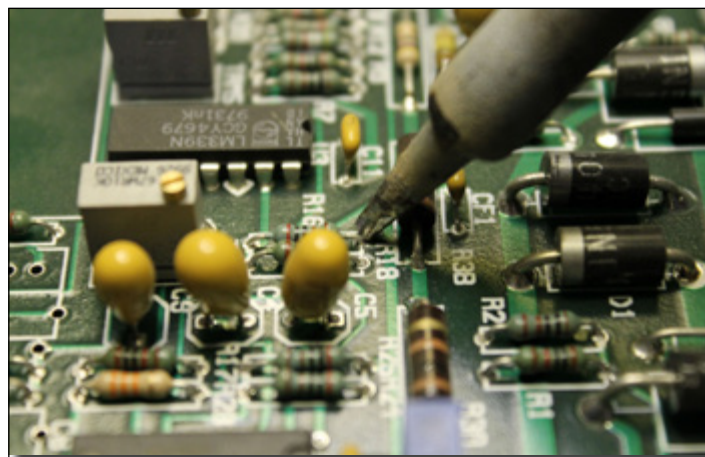
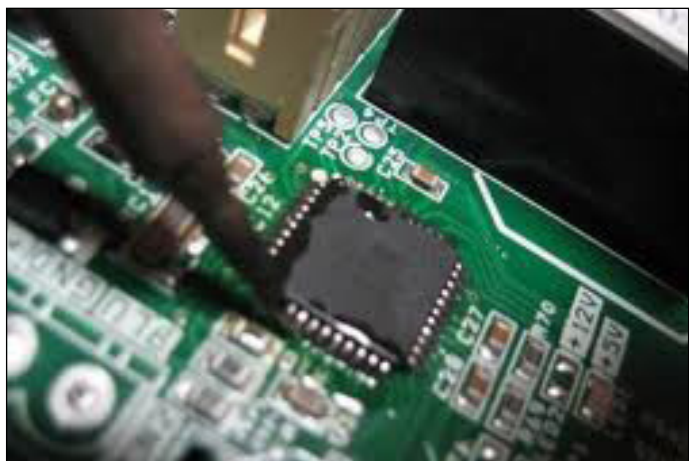

## Ricambi - Spare parts - Pièces de rechange - Ersatzteile - Recambios

### MINI-90/CAPPE

Supporto magnetico  
Magnetic support  
Support magnetique  
Magnet Halterung  
Soporte Magnético



### MINI-90/TUBO

Ø 60 mm - L. 3 mt



### MINI-90/RIC



### MINI-90/CONT1

2 Kg Carboni att.  
2 Kg Active Carb.  
2 Kg Carbon Act.  
2 Kg Aktivkohle  
2 Kg Carbon Act.



Rif.	mm
A	280
B	342
C	534
D	60

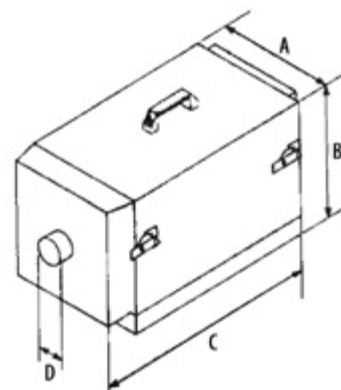

## Dettagli tecnici - Technical details - Données techniques - Technische Daten - Datos Técnicos

Model	W	m <sup>3</sup> /h	c.f.m.	mm H <sub>2</sub> O	Pa	%	Kg	Lbs	Carb. Kg	Carb. Lbs	m <sup>2</sup>	dB	V/Hz	L. flex
MINI90-NEW	1150	140	83	2400	240	99	20	44	2	4,4	1,03	73	230/50	3 mt